

CT Installation Manual Guide

(Part No.: 2809000900 Release Date: August, 2020)

1. Scope

CSI inverters integrate the export limitation function, to use this function, please read this installation guide to install the CT sensor and set the inverter. This CT sensor applies to PV inverter models: CSI-3K-S22002-ED, CSI-5K-S22002-ED, CSI-3K-S22002-E, CSI-5K-S22002-E.

2. CT Specification

| | |
|-----------------------------------|-------------------------------|
| Model Name | CTSA016-100A/33.33mA |
| Rated primary current | 100 A |
| Rated secondary current | 33.33 mA |
| Secondary load | 10 Ω |
| Power frequency withstand voltage | 4000V / 10S, 1mA |
| Insulation resistance | 100MΩ @ 500Vdc |
| Accuracy | ± 0.5 % |
| Maximum current | 120 A continuous |
| Environmental protection | ROHS |
| Dotted terminal | P1 and red cable |
| Dimension (W x H x D, mm) | 30.5 X 49 X 34 mm |
| Signal cable length | 5 m (not including CT sensor) |

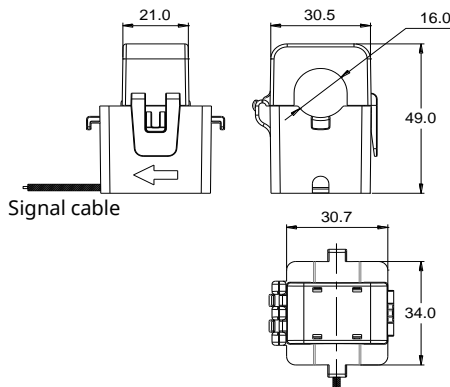

FIG1. Outline and Dimensions of CT

3. CT installation

3.1 System diagram.

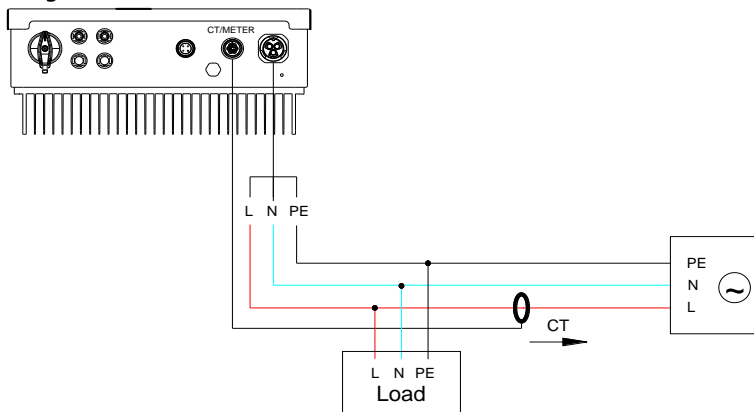

FIG.2 Electrical and signal connection diagram

3.2 Wiring signal cable

3.2.1 Wiring signal connector

- 1) Diagram of connector, as per FIG.3.
- 2) Prepare the CT (signal) cable

Remove the CT cable's jacket about 23mm, and then strip the wire insulation layer by about 7mm, as per FIG.4.

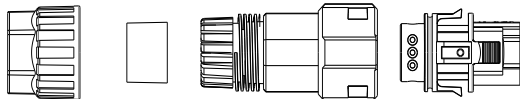

Pressure Nut Sealing Ring Threaded Sleeve Plug (Meter Pins and shell)

FIG.3 Components of Connector

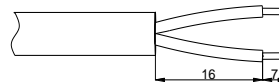

FIG.4 Strip Signal Cable

Recommend the specification of the signal cable:

| Cable Type | Conductor Cross-Sectional Area | Outer Diameter |
|------------------|------------------------------------|----------------|
| Two cores cable. | 0.2-0.75mm ² (24-18AWG) | 3.5-5.5mm |

Note: Signal cable length (not including CT sensor) is 5m. For extension cables, please see above specifications.

- 3) Insert the conductors into the corresponding pins of the plug, and then fix the conductors by screws firmly.

Tool: Phillips screwdriver #1. Torque: 0.6-0.8N.m.

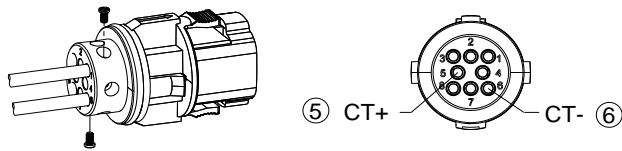

| CT Connector of inverter side | CT Side |
|-------------------------------|-------------|
| Pin - 5 | CT+ (red) |
| Pin - 6 | CT- (black) |

FIG.5 The pin positions of connector

- 4) Tighten the pressure nut, and then push the threaded sleeve into the plug, as per FIG.6.
- 5) Finally insert the assembled connector into the CT/Meter receptacle on the inverter.

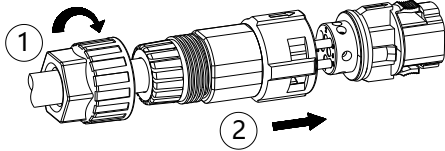

FIG.6 Assembling the Connector

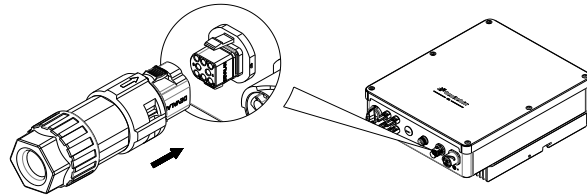

FIG.7 Insert the connector into receptacle

3.3 Install the CT

Warning: DISCONNECT both DC & AC connections before install the CT. Otherwise there will be risk of electric shock.

Install procedure:

- 1) Open the buckle of CT, as per FIG.7
- 2) Stuck CT on the tested cable (pole-L), then close the buckle, as per FIG.8 and FIG.2.
Note: The current in line must meet the allowable value of CT (check the specification in section 2).
The current direction must be consistent with the arrow direction on the shell of CT.
- 3) Fix the CT with cable tie to prevent slipping, as per FIG.9.
- 4) Check the current and current direction, turn on power.



FIG.7 Open the buckle

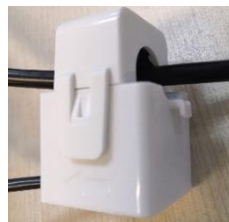

FIG.8 Install the CT



FIG.9 Fix the CT

3.4 Setting on the inverter (default setting is "OFF")

- 1) Enter CSI CloudPro APP;
- 2) Enter the "Local Mode", as per FIG.10;
- 3) Scan the QR code of WiFi stick or input the serial number of WiFi stick manually. Then connect to the AP of WiFi stick, as per FIG.11;
- 4) Enter the "Parameters" page (password "000000");
- 5) Enter the "EPM" page:
Set "EPM Mode" to "CT";
Set all the parameters refer to the local requirement, as per FIG.12 (such as "EPM power setting", "Fail safe Power Setting" etc.)
- 6) User "CT Link Test" to check if the installation is correct;
- 7) Exit local mode.

Please refer to CSI CloudPro APP User Manual for CSI CloudPro App details.

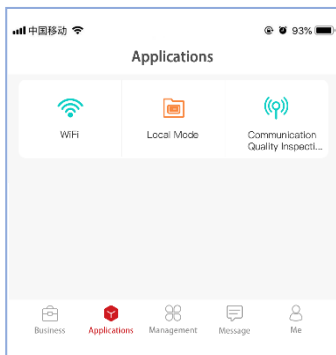

FIG. 10 Enter local Mode



FIG.11 Connect to WiFi stick

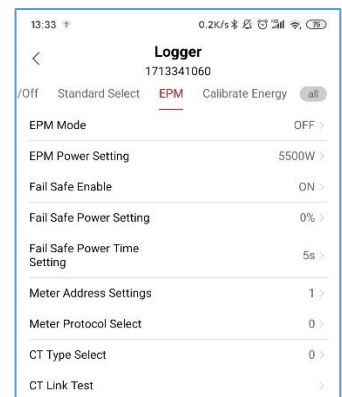
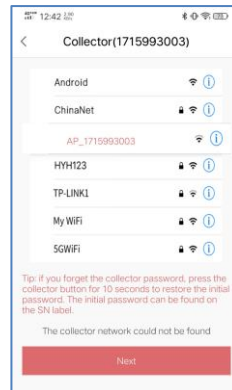

FIG.12 Default setting of EPM page