





BiHiKu7

BIFACIAL MONO PERC



575 W ~ 600 W

CS7L-575 | 580 | 585 | 590 | 595 | 600MB-AG

MORE POWER

-  Module power up to 600 W
Module efficiency up to 21.2 %
-  Up to 8.9 % lower LCOE
Up to 4.6 % lower system cost
-  Comprehensive LID / LeTID mitigation technology, up to 50% lower degradation
-  Compatible with mainstream trackers, cost effective product for utility power plant
-  Better shading tolerance

MORE RELIABLE

-  40 °C lower hot spot temperature, greatly reduce module failure rate
-  Minimizes micro-crack impacts
-  Heavy snow load up to 5400 Pa, wind load up to 2400 Pa*

FRONT

BACK



Enhanced Product Warranty on Materials and Workmanship*



Linear Power Performance Warranty*

**1st year power degradation no more than 2%
Subsequent annual power degradation no more than 0.45%**

*According to the applicable Canadian Solar Limited Warranty Statement.

MANAGEMENT SYSTEM CERTIFICATES*

ISO 9001:2015 / Quality management system
ISO 14001:2015 / Standards for environmental management system
ISO 45001: 2018 / International standards for occupational health & safety

PRODUCT CERTIFICATES*

IEC 61215 / IEC 61730 / CE / INMETRO / MCS / UKCA
CEC listed (US California) / FSEC (US Florida)
UL 61730 / IEC 61701 / IEC 62716 / IEC 60068-2-68
Take-e-way



* The specific certificates applicable to different module types and markets will vary, and therefore not all of the certifications listed herein will simultaneously apply to the products you order or use. Please contact your local Canadian Solar sales representative to confirm the specific certificates available for your Product and applicable in the regions in which the products will be used.

CSI Solar Co., Ltd. is committed to providing high quality solar photovoltaic modules, solar energy and battery storage solutions to customers. The company was recognized as the No. 1 module supplier for quality and performance/price ratio in the IHS Module Customer Insight Survey. Over the past 20 years, it has successfully delivered over 63 GW of premium-quality solar modules across the world.

* For detailed information, please refer to the Installation Manual.

ENGINEERING DRAWING (mm)

Rear View

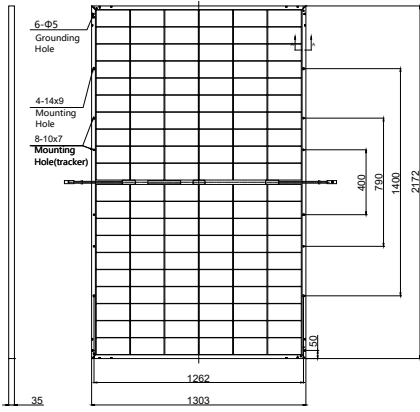

Frame Cross Section A-A

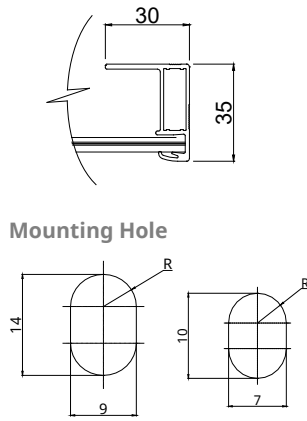

CS7L-580MB-AG / I-V CURVES

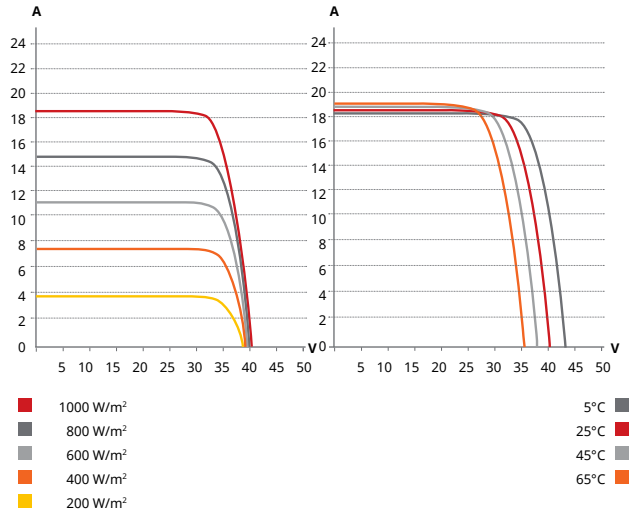

ELECTRICAL DATA | STC*

	Nominal Max. Power (Pmax)	Opt. Operating Voltage (Vmp)	Opt. Operating Current (Imp)	Open Circuit Voltage (Voc)	Short Circuit Current (Isc)	Module Efficiency	
CS7L-575MB-AG	575 W	33.9 V	16.97 A	40.3 V	18.22 A	20.3%	
Bifacial Gain**	5%	604 W	33.9 V	17.82 A	40.3 V	19.13 A	21.3%
	10%	633 W	33.9 V	18.68 A	40.3 V	20.04 A	22.4%
	20%	690 W	33.9 V	20.36 A	40.3 V	21.86 A	24.4%
CS7L-580MB-AG	580 W	34.1 V	17.02 A	40.5 V	18.27 A	20.5%	
Bifacial Gain**	5%	609 W	34.1 V	17.87 A	40.5 V	19.18 A	21.5%
	10%	638 W	34.1 V	18.72 A	40.5 V	20.10 A	22.5%
	20%	696 W	34.1 V	20.42 A	40.5 V	21.92 A	24.6%
CS7L-585MB-AG	585 W	34.3 V	17.06 A	40.7 V	18.32 A	20.7%	
Bifacial Gain**	5%	614 W	34.3 V	17.91 A	40.7 V	19.24 A	21.7%
	10%	644 W	34.3 V	18.78 A	40.7 V	20.15 A	22.8%
	20%	702 W	34.3 V	20.47 A	40.7 V	21.98 A	24.8%
CS7L-590MB-AG	590 W	34.5 V	17.11 A	40.9 V	18.37 A	20.8%	
Bifacial Gain**	5%	620 W	34.5 V	17.98 A	40.9 V	19.29 A	21.9%
	10%	649 W	34.5 V	18.82 A	40.9 V	20.21 A	22.9%
	20%	708 W	34.5 V	20.53 A	40.9 V	22.04 A	25.0%
CS7L-595MB-AG	595 W	34.7 V	17.15 A	41.1 V	18.42 A	21.0%	
Bifacial Gain**	5%	625 W	34.7 V	18.02 A	41.1 V	19.34 A	22.1%
	10%	655 W	34.7 V	18.88 A	41.1 V	20.26 A	23.1%
	20%	714 W	34.7 V	20.58 A	41.1 V	22.10 A	25.2%
CS7L-600MB-AG	600 W	34.9 V	17.20 A	41.3 V	18.47 A	21.2%	
Bifacial Gain**	5%	630 W	34.9 V	18.06 A	41.3 V	19.39 A	22.3%
	10%	660 W	34.9 V	18.92 A	41.3 V	20.32 A	23.3%
	20%	720 W	34.9 V	20.64 A	41.3 V	22.16 A	25.4%

* Under Standard Test Conditions (STC) of irradiance of 1000 W/m², spectrum AM 1.5 and cell temperature of 25°C.
 ** Bifacial Gain: The additional gain from the back side compared to the power of the front side at the standard test condition. It depends on mounting (structure, height, tilt angle etc.) and albedo of the ground.

ELECTRICAL DATA | NMOT*

	Nominal Max. Power (Pmax)	Opt. Operating Voltage (Vmp)	Opt. Operating Current (Imp)	Open Circuit Voltage (Voc)	Short Circuit Current (Isc)
CS7L-575MB-AG	431 W	31.8 V	13.56 A	38.1 V	14.69 A
CS7L-580MB-AG	435 W	32.0 V	13.60 A	38.3 V	14.73 A
CS7L-585MB-AG	439 W	32.2 V	13.64 A	38.5 V	14.77 A
CS7L-590MB-AG	442 W	32.3 V	13.70 A	38.7 V	14.80 A
CS7L-595MB-AG	446 W	32.5 V	13.73 A	38.8 V	14.85 A
CS7L-600MB-AG	450 W	32.7 V	13.77 A	39.0 V	14.89 A

* Under Nominal Module Operating Temperature (NMOT), irradiance of 800 W/m² spectrum AM 1.5, ambient temperature 20°C, wind speed 1 m/s.

MECHANICAL DATA

Specification	Data
Cell Type	Mono-crystalline
Cell Arrangement	120 [2 x (10 x 6)]
Dimensions	2172 x 1303 x 35 mm (85.5 x 51.3 x 1.38 in)
Weight	34.6 kg (76.3 lbs)
Front Glass	2.0 mm heat strengthened glass with anti-reflective coating
Back Glass	2.0 mm heat strengthened glass
Frame	Anodized aluminium alloy
J-Box	IP68, 3 bypass diodes
Cable	4.0 mm ² (IEC), 10 AWG (UL)
Cable Length (Including Connector)	460 mm (18.1 in) (+) / 340 mm (13.4 in) (-) (supply additional jumper cable: 2 lines / Pallet) or customized length*
Connector	T4 series or MC4-EVO2
Per Pallet	31 pieces
Per Container (40' HQ)	527 pieces

* For detailed information, please contact your local Canadian Solar sales and technical representatives.

ELECTRICAL DATA

Operating Temperature	-40°C ~ +85°C
Max. System Voltage	1500 V (IEC/UL) or 1000 V (IEC/UL)
Module Fire Performance	TYPE 29 (UL 61730) or CLASS C (IEC61730)
Max. Series Fuse Rating	35 A
Application Classification	Class A
Power Tolerance	0 ~ +10 W
Power Bifaciality*	70 %

* Power Bifaciality = $P_{max_{rear}} / P_{max_{front}}$, both $P_{max_{rear}}$ and $P_{max_{front}}$ are tested under STC, Bifaciality Tolerance: ± 5 %

TEMPERATURE CHARACTERISTICS

Specification	Data
Temperature Coefficient (Pmax)	-0.34 % / °C
Temperature Coefficient (Voc)	-0.26 % / °C
Temperature Coefficient (Isc)	0.05 % / °C
Nominal Module Operating Temperature	41 ± 3°C

* The specifications and key features contained in this datasheet may deviate slightly from our actual products due to the on-going innovation and product enhancement. CSI Solar Co., Ltd. reserves the right to make necessary adjustment to the information described herein at any time without further notice.

Please be kindly advised that PV modules should be handled and installed by qualified people who have professional skills and please carefully read the safety and installation instructions before using our PV modules.

PARTNER SECTION

